

Profil LED / Profile LED

INSO

Karta produktu Data sheet

PL

Profil wpuszczany – do oświetlenia pomieszczeń biurowych, sklepowych, domowych – oświetlenie architektoniczne – sufitowe, ścienne.

EN

Groove mounted profile – for lighting in offices, stores and homes – architectural lighting – ceiling- and wall-mounted.

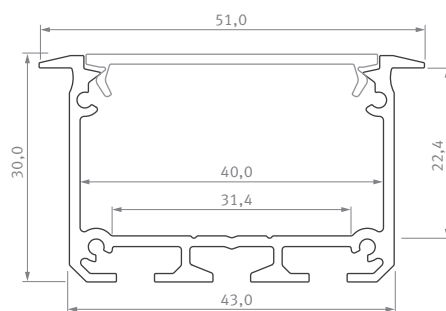

Sposoby montażu /
Assembly methods



Obejrzyj wideo /
Watch video



INSO

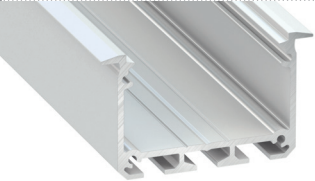
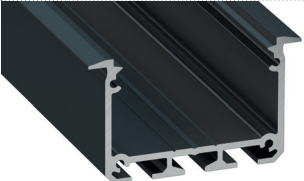
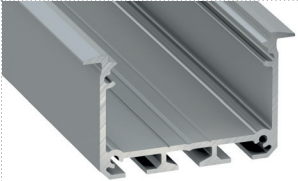

Profil LED / Profile LED

Wymiary [mm] / Dimensions (mm): 1000, 2020, 3000





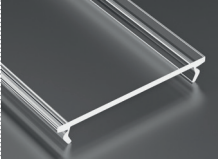
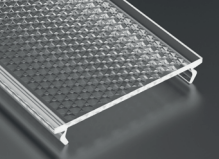
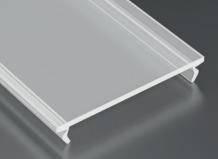

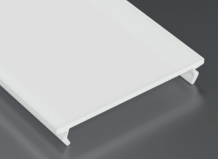
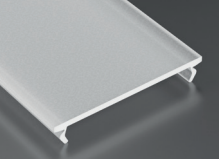

	BIAŁY (lakierowany) white (lacquered)	CZARNY (lakierowany) black (lacquered)	SREBRNY (anodowany) silver (anodized)
Kolory profili Profile colors			
1,0 m	10-0121-10	10-0125-10	10-0124-10
2,02 m	10-0121-20	10-0125-20	10-0124-20
3,0 m	10-0121-30	10-0125-30	10-0124-30
Szerokość taśmy LED (mm) LED strip width (mm)	3 × 10		

Klosze (PVC/PMMA/PC) / Covers







Wymiary [mm] / Dimensions (mm): 1000, 2020, 3000

TRANSPARENTNY transparent	MROŻONY frozen	MLECZNY milky	FROSTED MLECZNY milky frosted	TRANSPARENTNY transparent	SREBRNY silver
WIDE			PRISMATIC PC		
					
					
					
1 m/PMMA 11-2033-10 1 m/PC 11-3033-10	1 m/PMMA 11-2032-10 1 m/PC 11-3032-10	1 m/PMMA 11-2031-10 1 m/PC 11-3031-10	1 m/PMMA 11-2036-10	1 m/PC 11-3034-10	1m/ 14-7068-00

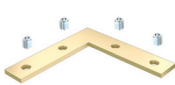
Zaślepki (aluminium i tworzywo sztuczne) / End caps (aluminum and plastic)

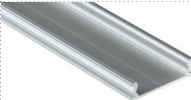
Z OTWOREM with a hole			BEZ OTWORU without a hole		
BIAŁY white	CZARNY black	SREBRNY / SZARY silver / gray	BIAŁY white	CZARNY black	SREBRNY silver
					
ALU 12-0000-12	ALU 12-0000-78	ALU 12-0000-13	ALU 12-0121-11	ALU 12-0122-11	ALU 12-0125-11
					
			ABS 12-0121-01		ABS łącz. 12-0125-01 ABS 12-0124-01

Dodatki / Accessories

ŁĄCZNIK PROSTY straight connector	ŁĄCZNIK KĄTOWY 90° angular connector 90°	ŁĄCZNIK POPRZECZNY KĄTOWY angular transverse connector	ŁĄCZNIK KĄTOWY 120° angular connector 120°
			
14-3032-02	14-3030-01	14-3038-01	14-3036-01
PROFIL MONTAŻOWY MODI mounting profile MODI			SPRĘŻYNY MONTAŻOWE mounting springs
			
*S 1 m/10-0134-10	*W 10-0131-10	*B 10-0135-10	14-5001-00

* S SREBRNY silver; * B CZARNY black; * W BIAŁY white

Maksymalna rozpraszana moc źródeł światła LED

Maximum dissipated power of LED light sources

dla temperatury profilu for temperature profile 55° C	dla temperatury profilu for temperature profile 65° C
61,5 W	84 W

LUMINES[®]
LIGHTING

www.lumines.pl

