

FEATURES

- Compact size, slim design, light weight
- High efficiency, low temperature rise
- Protections: Protections: short circuit, overload, over temperature
- Cooling by free air convection
- Compliance to worldwide regulations for lighting
 - IP20 protection
 - 5 years warranty

SPECIFICATION		PFV-50-12-B	PFV-50-24-B
OUTPUT	DC Voltage	12V	24V
	Rated Current	4.16A	2.08A
	Current Range	0 ÷ 4.16A	0 ÷ 2.08A
	Rated Power	50W	
	Line Regulation	± 3%	
	Load Regulation	± 3%	
	Setup, Rise Time (note 4.)	<1s, 100ms/230VAC at full load	
	Hold up time	10ms/230V at full load	
	Ripple & Noise (note 2.)	< 500mVp-p	
	Voltage Tolerance (note 3.)	± 5%	
INPUT	Voltage Range	198-264VAC	
	Frequency Range	47 ÷ 63Hz	
	Power factor (Typ.)	≥0.9	
	Efficiency (Typ.)	85%	
	AC Current (Typ.)	0.4A/220-240VAC	
	Inrush Current(Typ.)	60A/220-240VAC	
	Leakage Current	< 0.5mA/240VAC	
	No Load Power Consumption	≤0.5W	

PROTECTION	Over Current	Range: 110 ÷ 140% of rated current. Type: Hiccup mode. Re-start after fault condition is removed.
	Over Voltage	Range: 120 ÷ 150% of rated voltage. Type: re-start after fault condition is removed.
	Short Circuit	Hiccup mode. Re-start after fault condition is removed.
	Over Temperature	Range: 110°C ± 10°C Cut-off of the output voltage. After the termination of the thermal state, return to normal operation.
WORKING ENVIRONMENT	Working Temp.	-20 ÷ +45°C
	Working Humidity	45 ÷ 85%
	Storage Temp., Humidity	-40 ÷ +85°C, 5 ÷ 95% RH non-condensing
	Temp. Coefficient	±0.03%/°C (0 ~ 60°C)
SAFETY & EMC	Safety Standards	EN61347-1 EN61347-2-13
	Withstand Voltage	3000V/5mA/1min
	EMC Immunity	EN61547
	EMC Emission	EN55015
	Harmonic Current	EN61000-4-2,3,4,5, 6 EN61000-3-2 class C
OTHERS	Dimension	160 x 58 x 18 mm (L x W x H)
	Weight and Packing	50PCS/CTN--13KGS

NOTE:

1. All parameters NOT specially mentioned are measured at 230VAC input, rated load and 25°C of ambient temperature.
2. Ripple & noise are measured at 20MHz of bandwidth by using a 12" twisted pair-wire terminated with a 0.1µF i 47µF parallel capacitor.
3. Tolerance includes set up tolerance, line regulation and load regulation.
4. Length of set up time is measured at first cold start. Turning ON/OFF the power supply may lead to increase of the set up time.
5. The power supply is considered as a component that will be operated in combination with final equipment. Since EMC performance will be affected by the complete installation, the final equipment manufacturers must re-qualify EMC Directive on the complete installation again.

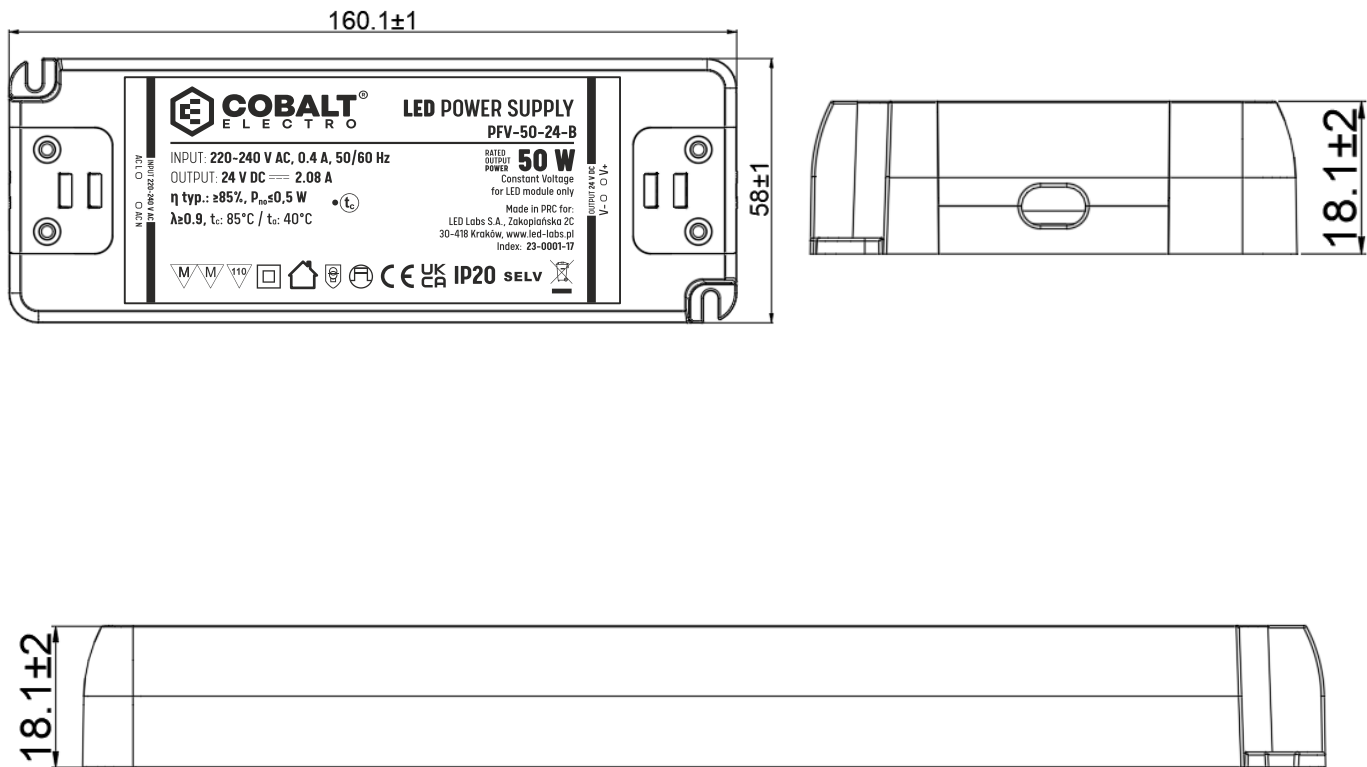

WIRING DIAGRAM

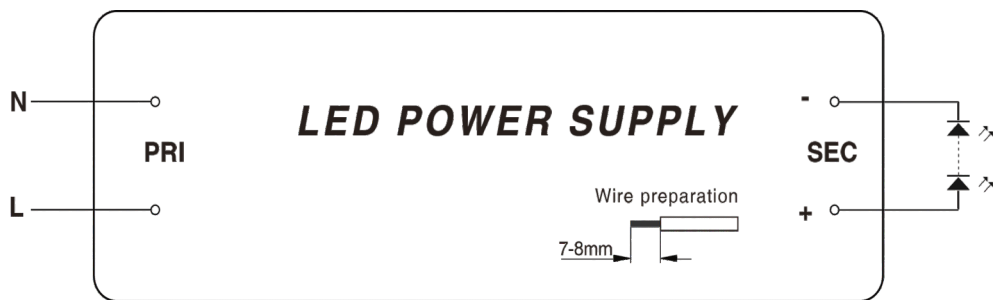

EXPLANATION OF THE SYMBOLS USED ON THE DEVICE



Short-circuit proof safety transformer



II IEC protection class



The device is designed to be placed on wooden surfaces in accordance with: DIN VDE 0710-14



Protective thermal protection 110°C



Risk of electric shock

SELV

Safe low voltage output not exceeding 50V AC or 120V DC

IP

Rate of protection against access to dangerous parts inside the housing, ingress of solids and water



Independent electronic transformer: it can be installed separately outside the luminaire without any additional housing